

SP011413-1 QUADRUPLE  
FRAMED SLIDING DOORS

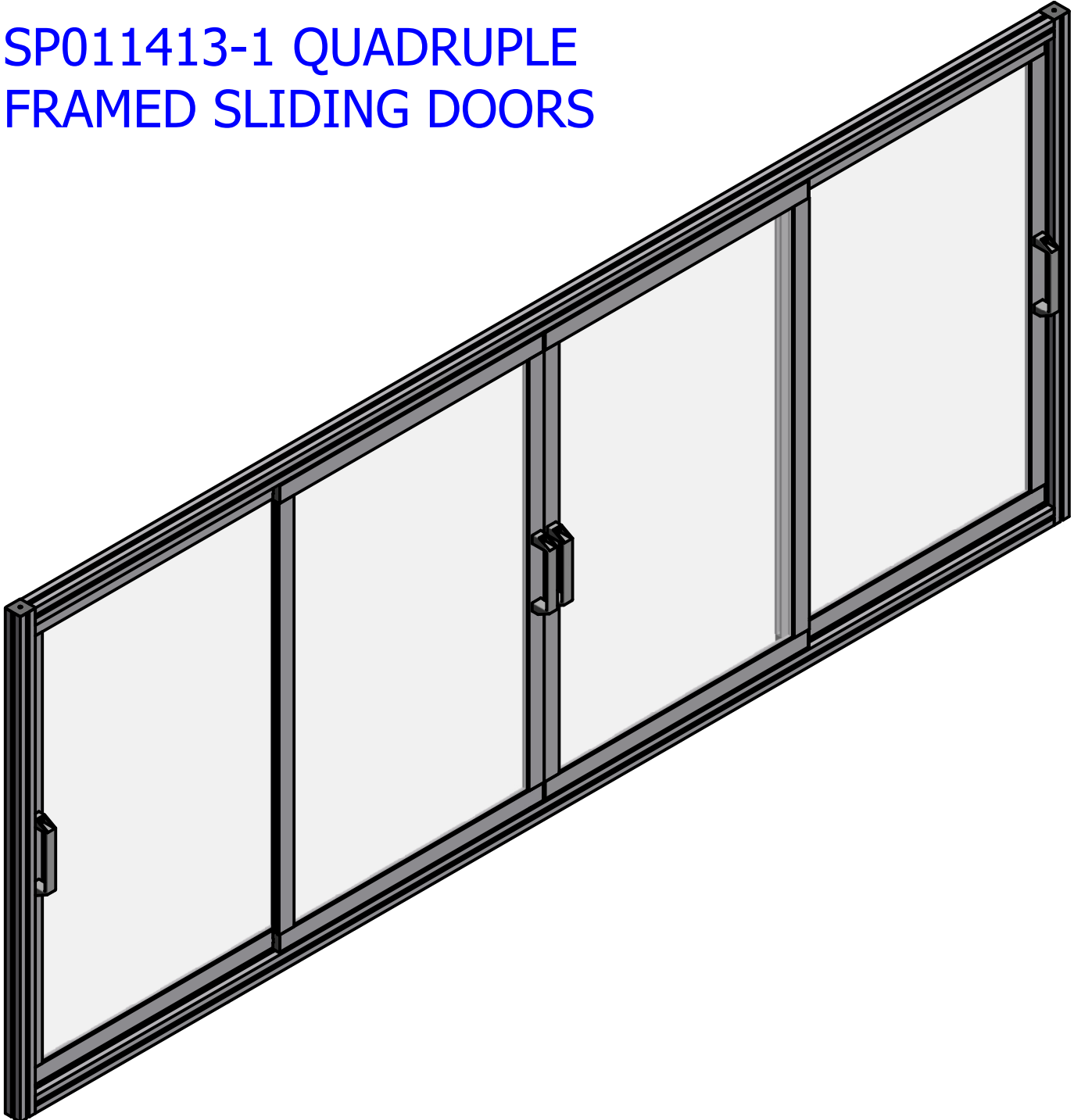

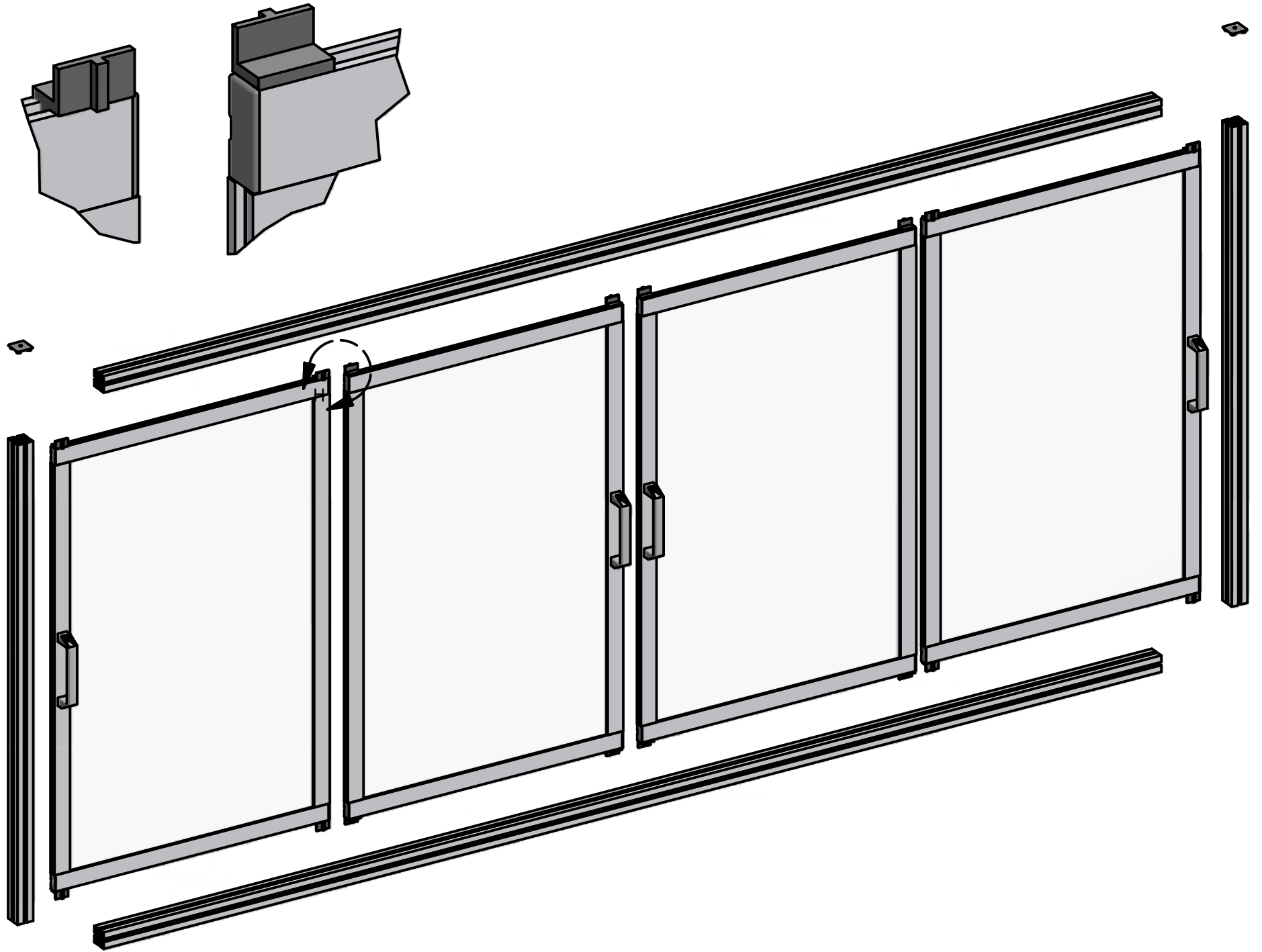

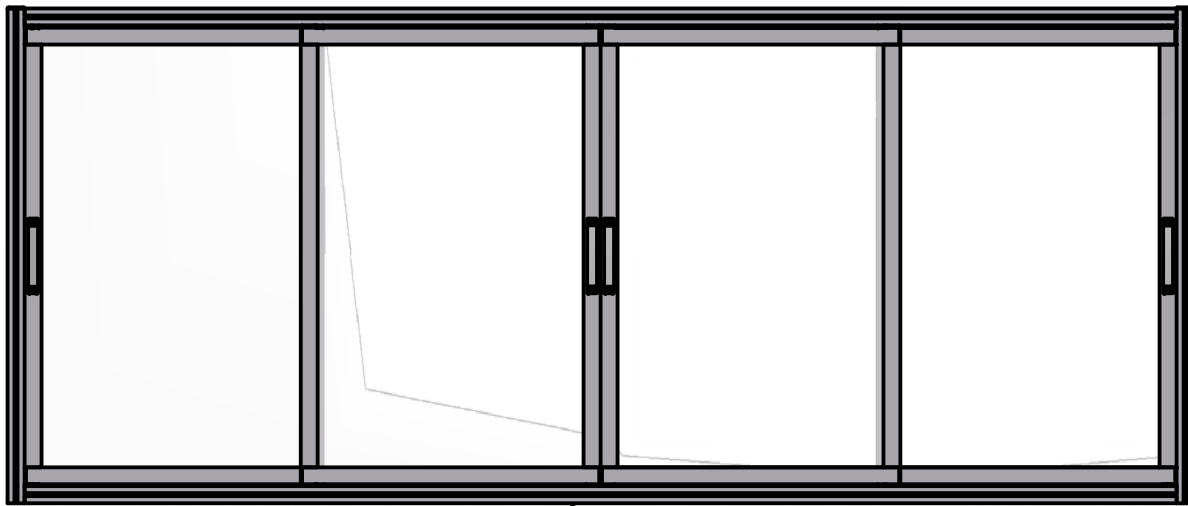
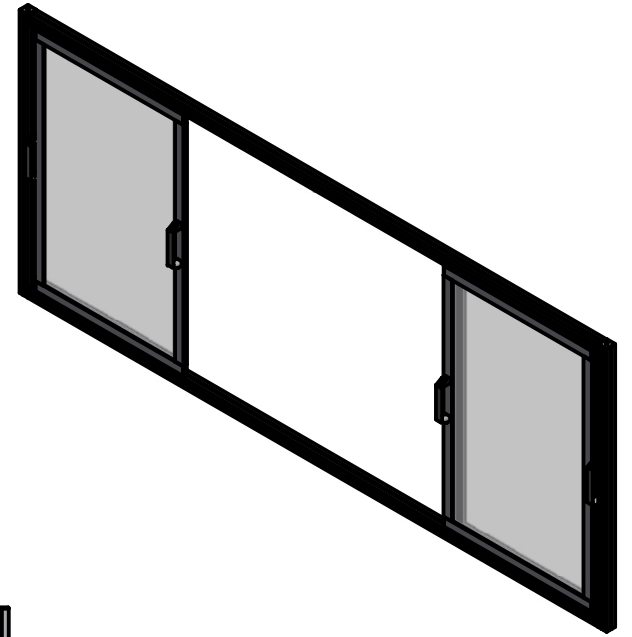
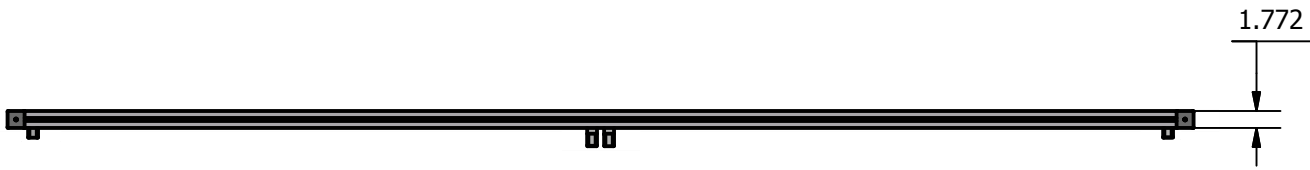

SUPPORT LOWER BAR IN  
CENTER IF IT'S NOT  
RESTING ON A SURFACE

**OPEN WIDTH**

DOOR WIDTH =  
 $\text{OPEN WIDTH} / 4 + 1''$

OPEN HEIGHT - 3.97''

OPEN HEIGHT + 3.54''

OPEN WIDTH + 3.54''

**OPEN HEIGHT**

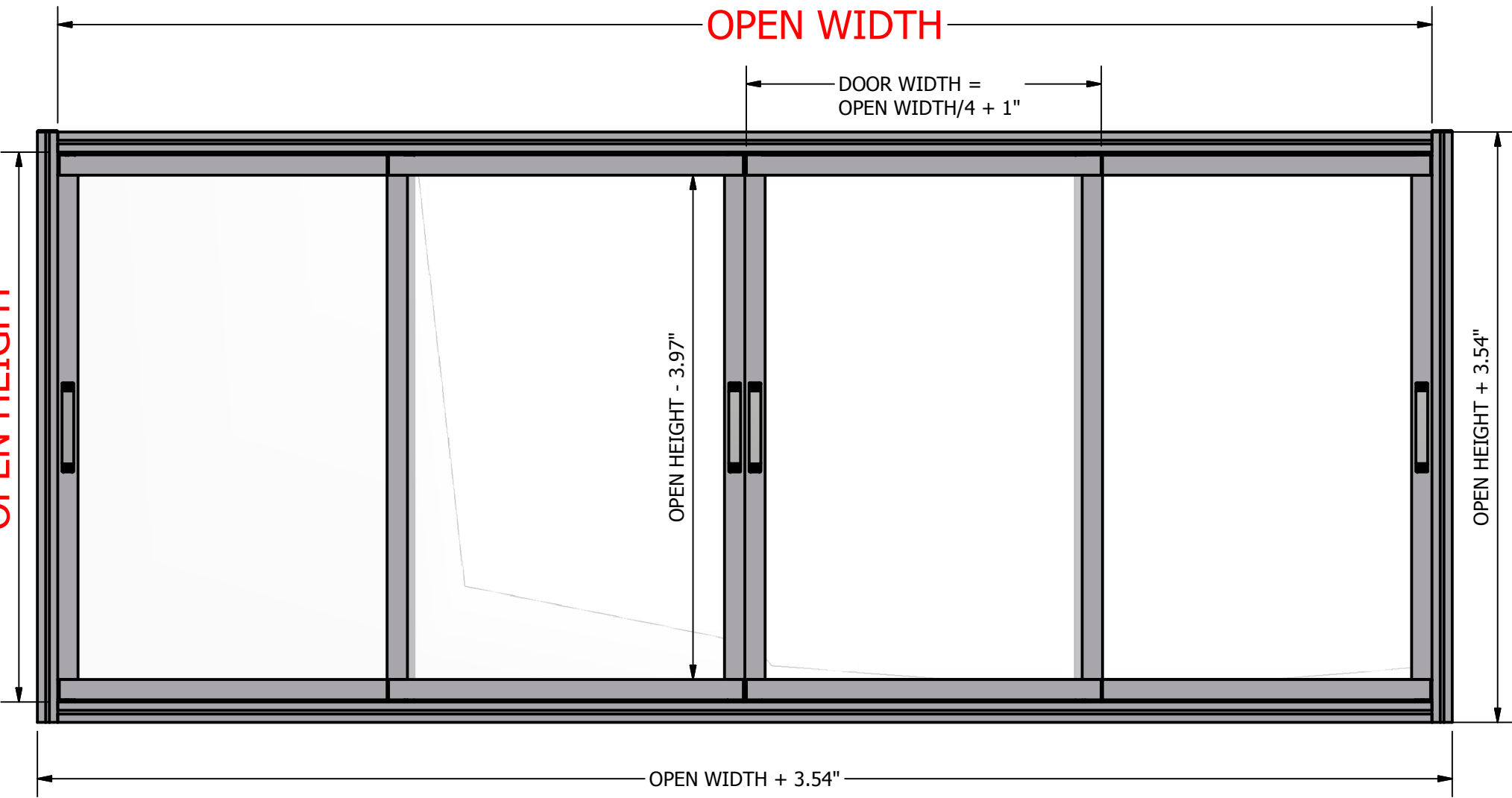

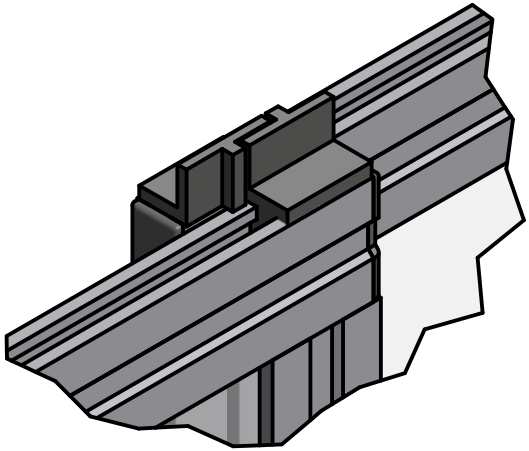

SHOWN WITHOUT  
TOP RAIL

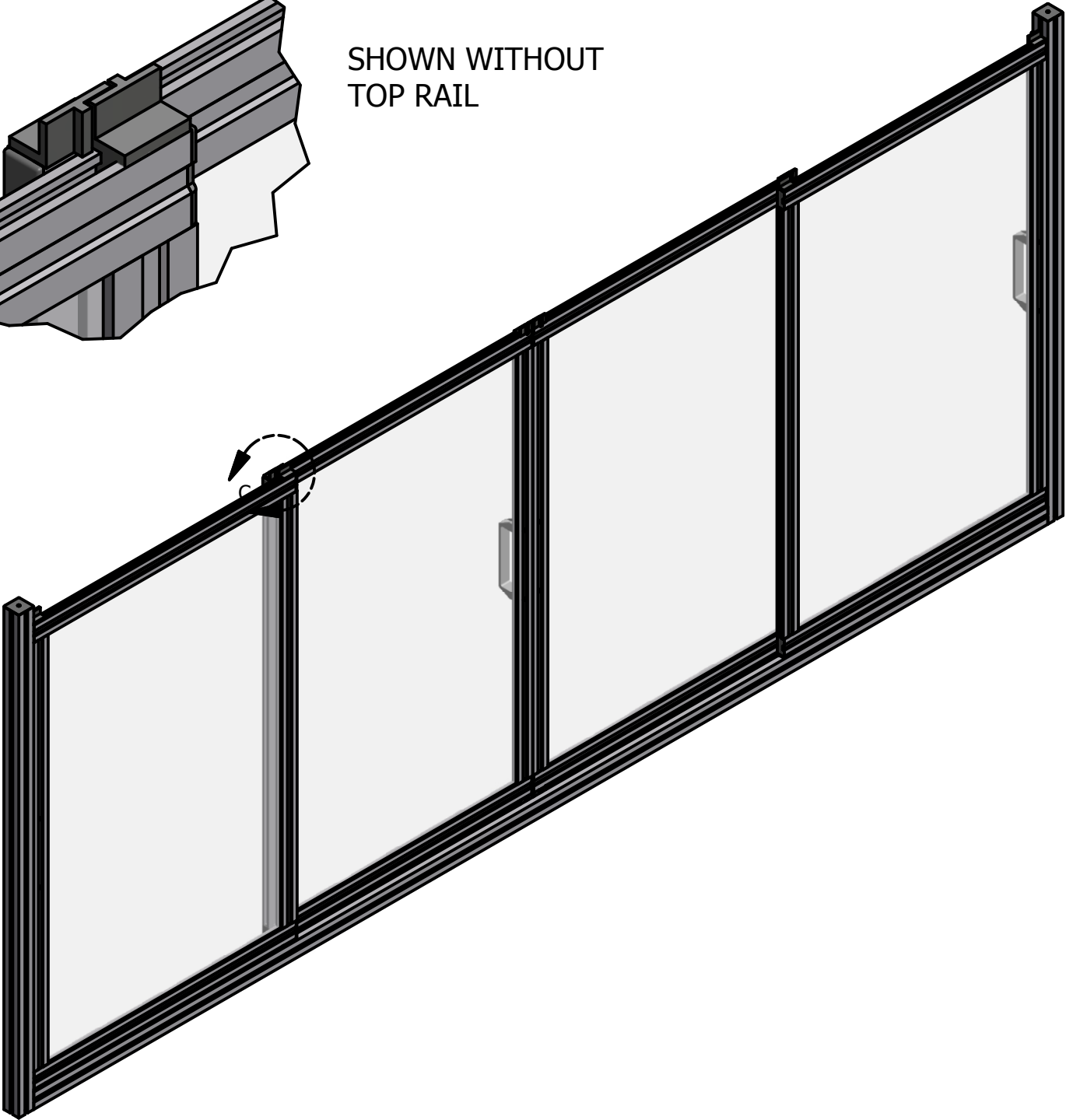

# FRONT DOOR

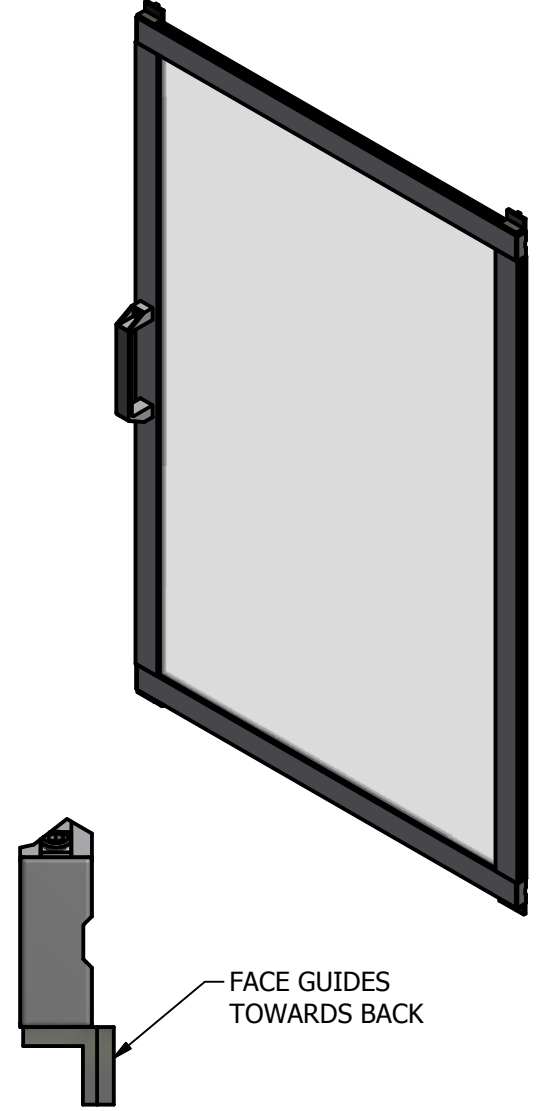
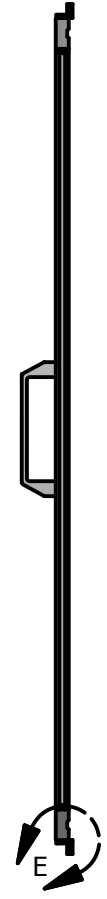
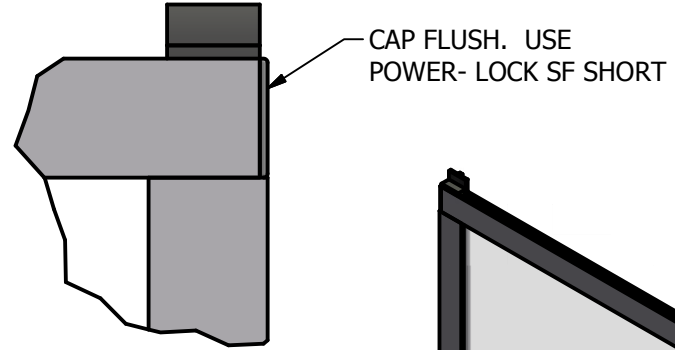
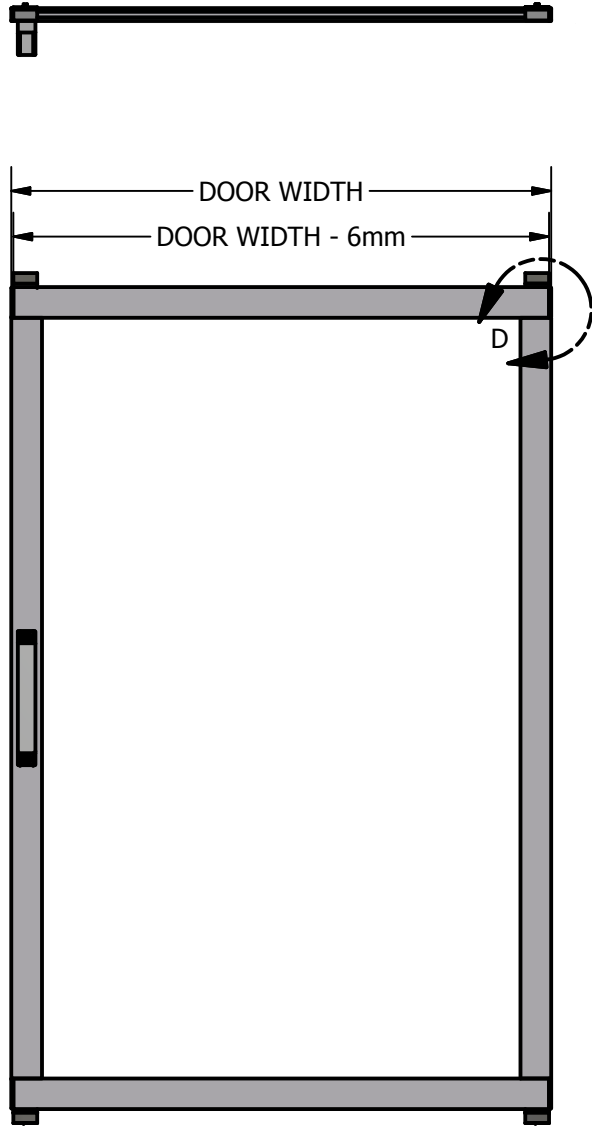

# BACK DOOR

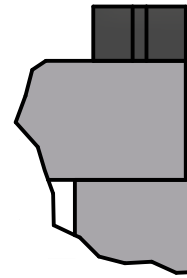

END CAP FLUSH USE  
POWER-LOCK SF SHORT

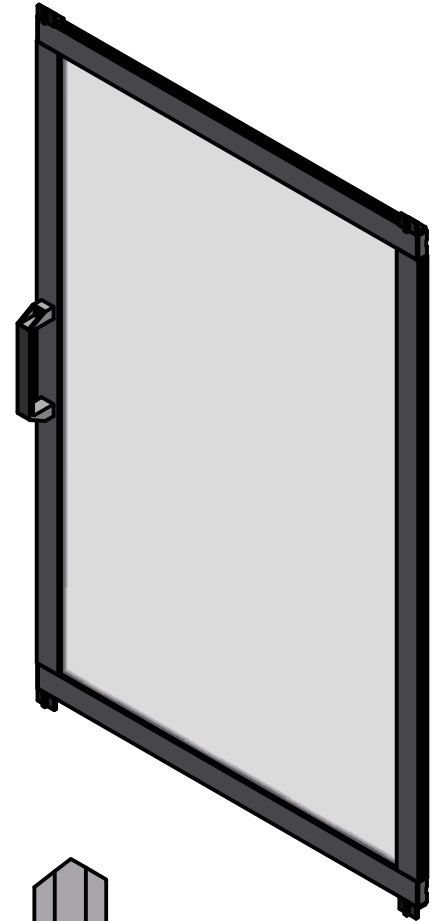
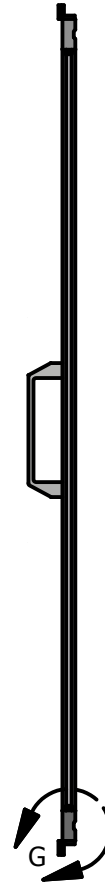
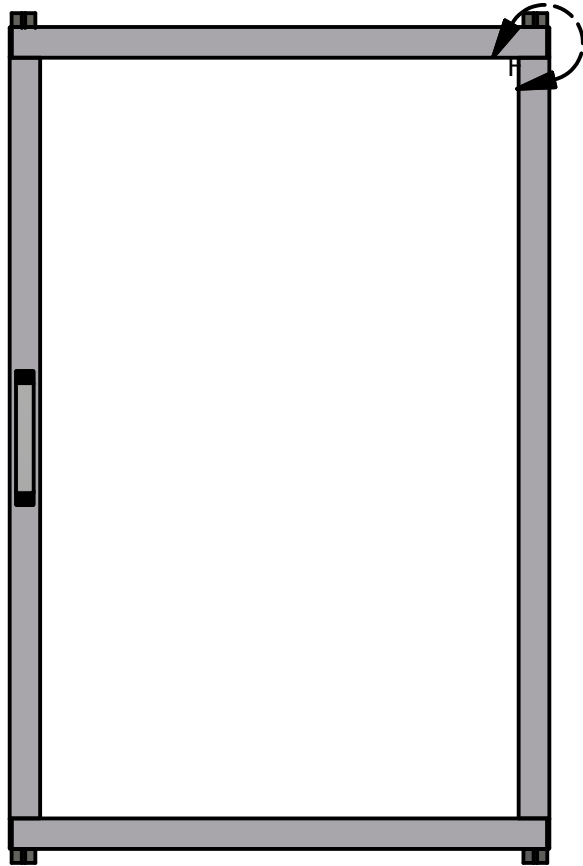

FACE GUIDES  
TOWARDS FRONT